

MVC940-C5-008

For the operation video, please refer to [MVC940-C5-008 Unboxing](#).

Minimum Requirements

- An audio (speakerµphone) system (purchase separately).
- A display connected to MCore Pro (not included).
- A Microsoft Teams Rooms or Skype® for Business account (not included).
- Wired network environment (not included).



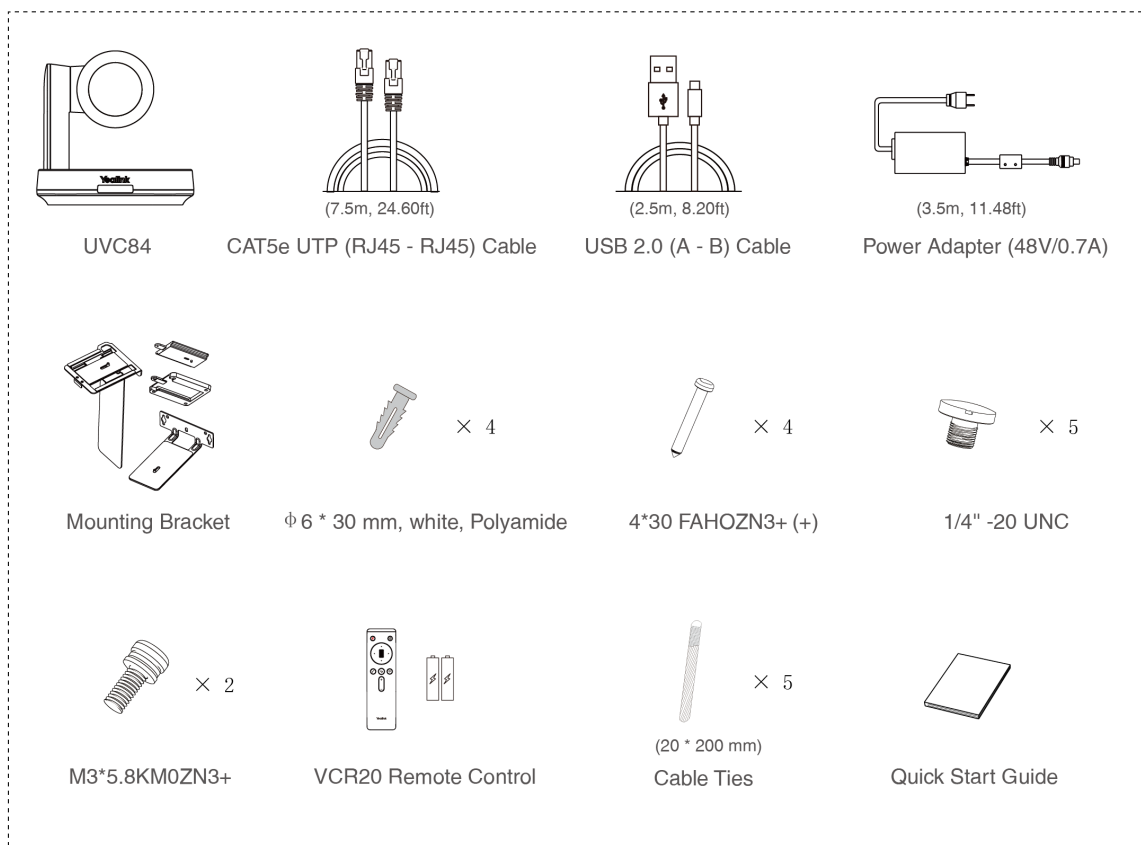



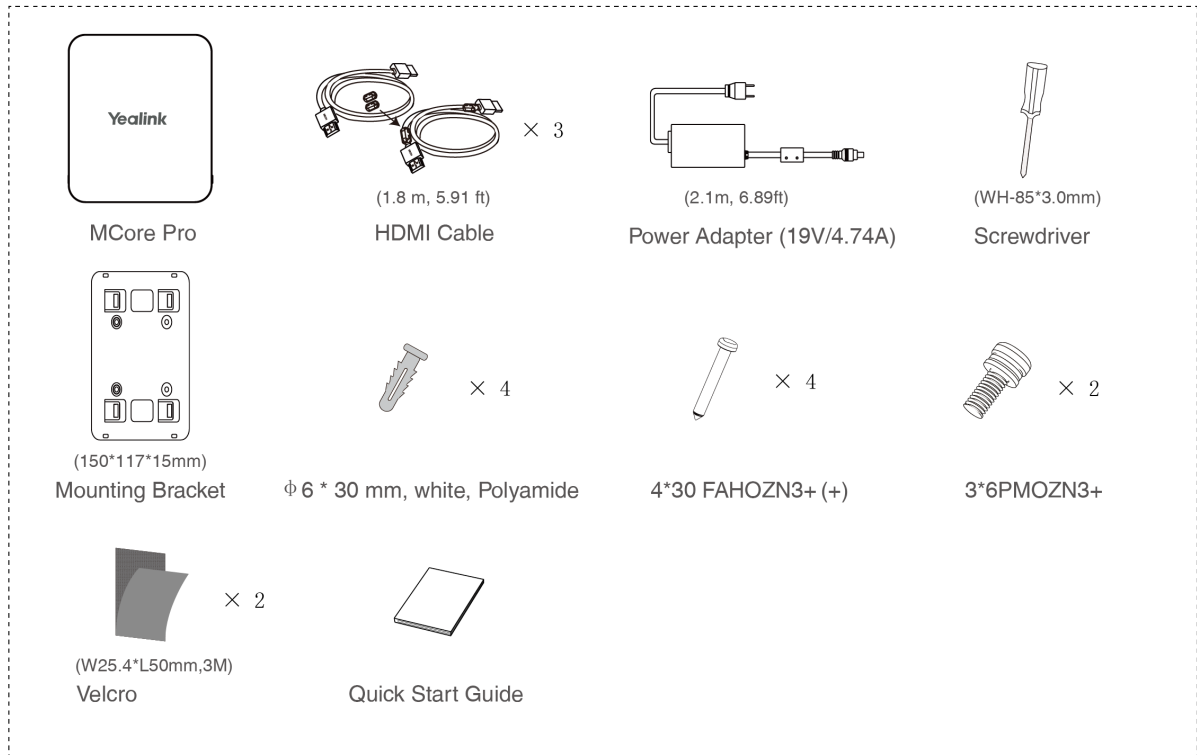





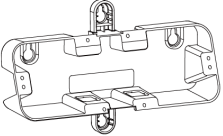

Package Contents



UVC84 Package*2



MCore Pro Package

			
MTouch Plus	CAT5e UTP (RJ45 - RJ45) Cable (7.5m, 24.6ft)	USB 3.1 (C - C, HDMI) Cable (1.2m, 3.94ft)	Screwdriver (WH-85*3.0mm)
			
Mounting Bracket (207.44 mm * 126.99 mm)	φ 6 * 30 mm, white, Polyamide × 4	4*30 FAHOZN3+ (+) × 4	2.5*9.0FMHZN(+) × 4
			
M8*60mm,SUS304 × 2	Washer (M8, φ30*T2mm, (M8,SUS304) SUS304) × 2	Wing Nuts (M8,SUS304) × 2	Double-Coating Tape (L200*W62.5*T1.2mm)
			
Lock cable buckle	2.5*8.0PAHOZN3+(+) × 4	Quick Start Guide	

MTouch Plus Package

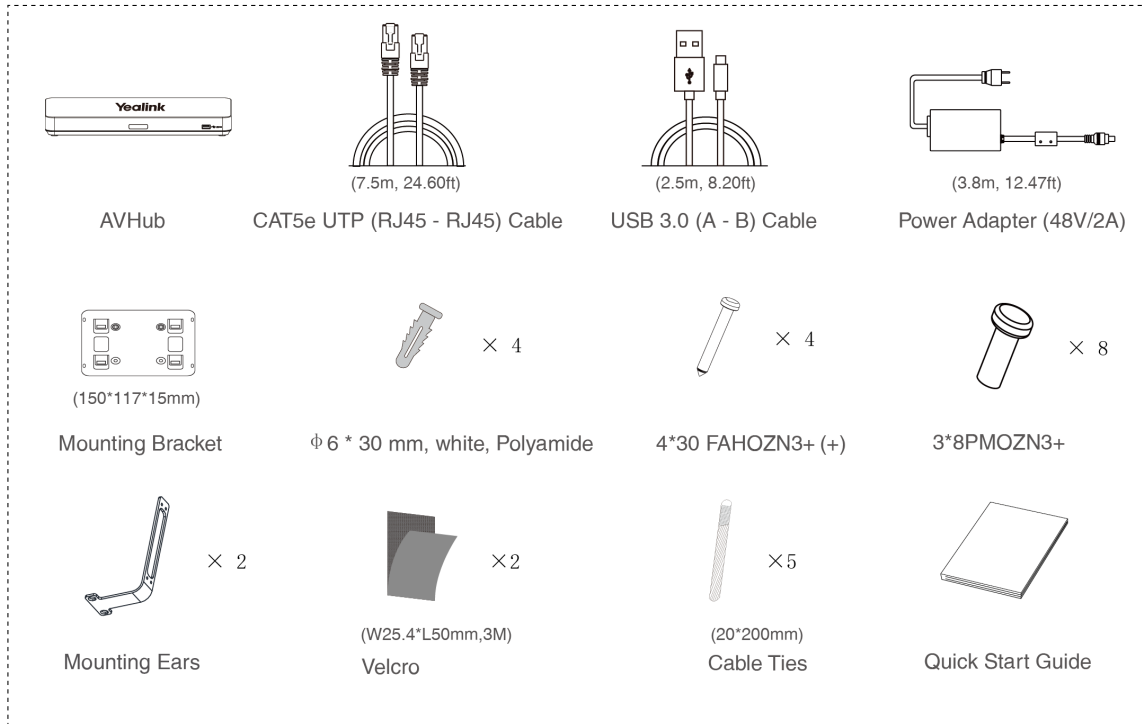

AVHub Package

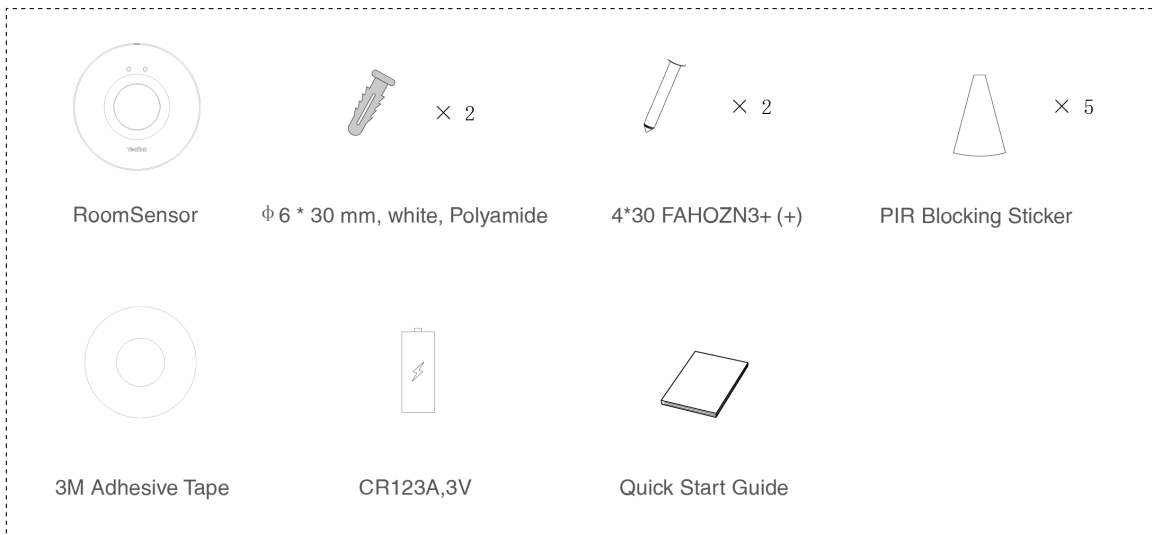

RoomSensor Package



WPP30 Package

Install MVC940-C5-008

- MCore Pro supports: mount on the wall, mount on the TV, stick to the table.
- MTouch Plus supports: put on a table, paste on a table, fixed on a table, mount on the wall.
- UVC84 supports: put on a flat surface, mount on top of a display, mount on the wall, mount on the ceiling, mount on the TV mount.
- AVHub supports: mount on the wall, stick under the table, put on the desk, mount on the rack.
- RoomSensor supports: mount on the ceiling, mount on the wall.
- Install and deploy the accessories in the system according to the environment and actual needs. For how to install and deploy, please refer to the quick start guide of each product.

Connect MVC940-C5-008

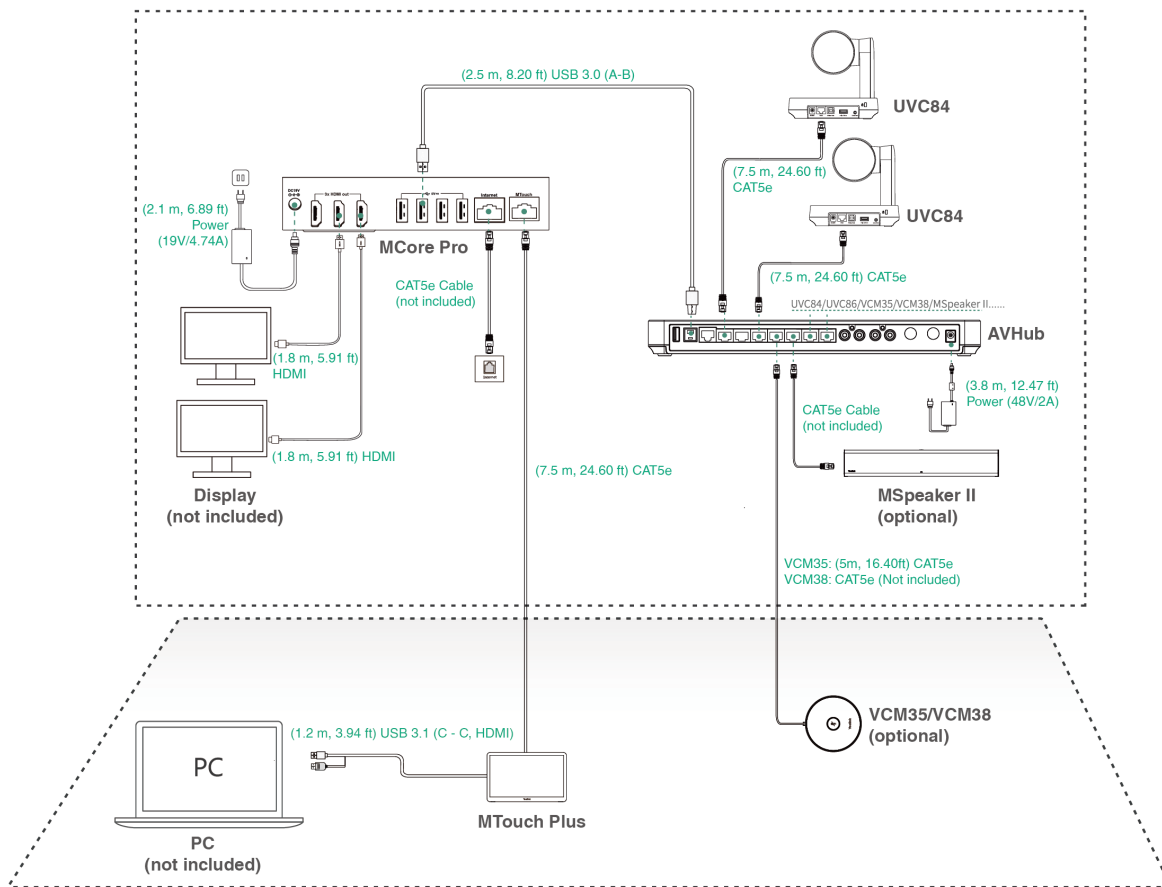

NOTE

- When starting up the system for the first time, you need to connect a mouse to complete the initial configuration. We recommend using the wireless mouse and keyboard kit.
- When you connect the UVC84/UVC86/MSpeaker II directly to the AVHub, the total number of connections must be no more than 4 devices. If the total number of connections exceeds 4 devices, you need to connect a PoE switch (the PoE switch must meet the 802.3 AT (PoE+) standard). We recommend using Yealink RCH40.
- Not included accessories requirements:
 - Display: Resolution of 1080p or higher and with an HDMI port.
 - PC: Equipped with HDMI or USB-C (support DP protocol) Port.
 - Ethernet cable: CAT5e or higher ethernet cable.
 - HDMI: Standard HDMI cable.

Initial Setup

1. Press the power button on the bottom left of MCore Pro, and the Microsoft Windows 10 IoT Enterprise Edition operating system will be automatically loaded after starting MCore Pro.

NOTE

When starting up the system for the first time, you need to connect a mouse to complete the initial configuration. We recommend using the wireless mouse and keyboard kit. After the system is initialized, you can use MTouch E2 to complete the system login and settings, and the device will automatically start the Microsoft Teams conference system application and enter the setting page.

2. Select the check box on the **EULA** page, and then tap **Next**.
3. Enter the account, the password on the **Account** page, and then tap **Next**. Supports Microsoft Teams Rooms or Skype® for Business accounts.
4. On the **Advanced** page, configure the domain and tap **Next**.
5. Tap **Finish** to complete the setup wizard.

Features

Wireless Sharing

1. Connect the WPP30 to the USB port of the MTouch E2.

When pairing, the LED indicator of WPP30 is orange. When the pairing is successful, the LED indicator turns green breathing light.

2. Connect the paired WPP30 to the USB-A/USB-C port on your PC.
3. On the WPP30, press the presentation button to share the full screen.



Control UVC84 Camera Position

1. Tap More >  to enter the Camera Control page.

Pair with a RoomSensor

1. Switch the account from Skype to Admin.
2. Open Yealink RoomConnect Software from the Desktop.
3. Go to **MTouch Plus > Sensor**.
4. Add sensor. Select the right sensor to pair.

Remove the back cover of RoomSensor, and you will see its name on the top. Then select accordingly.

NOTE

- A MTouch Plus can be paired with one RoomSensor at most.
- The distance between MTouch Plus and RoomSensor needs to be within 20m.

Supported Accessories

For the compatible devices and the maximum number of compatible devices, please refer to [Teams Room Accessories Compatibility Lists](#).