

# AVHub Installation

## Package Contents

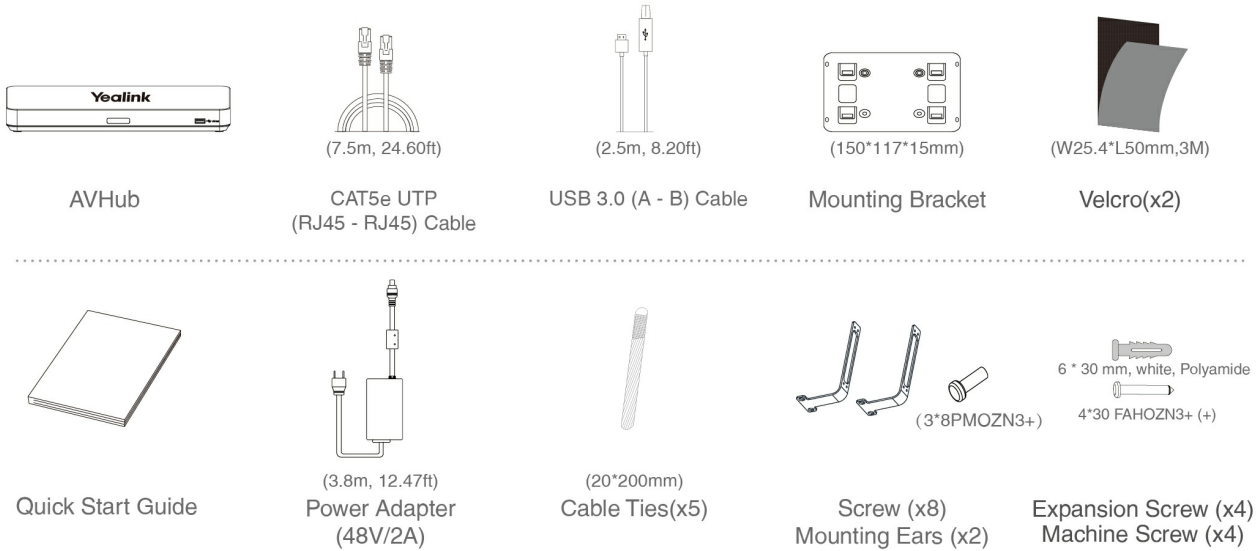

## Installation

### Mount on the Wall

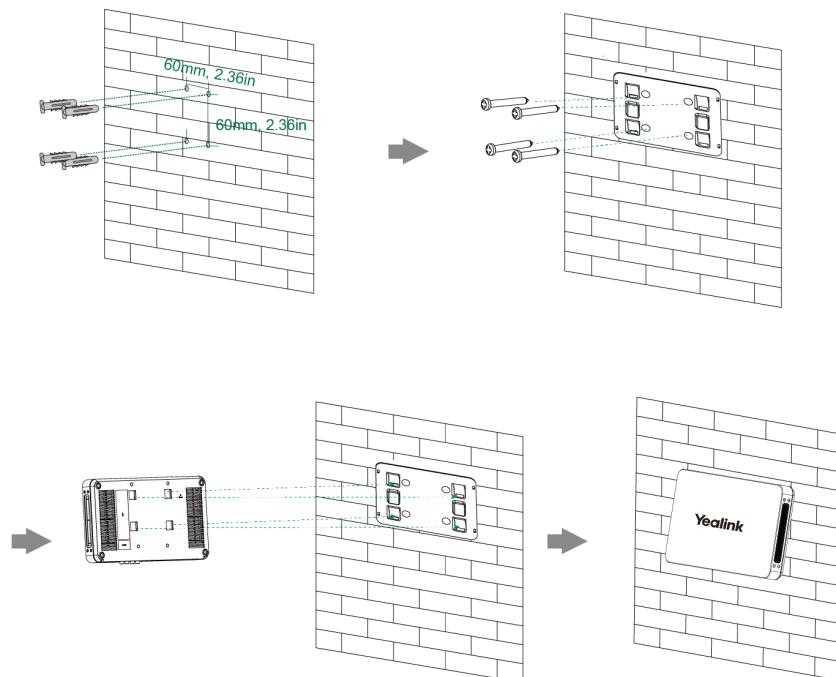

### Stick under the Table

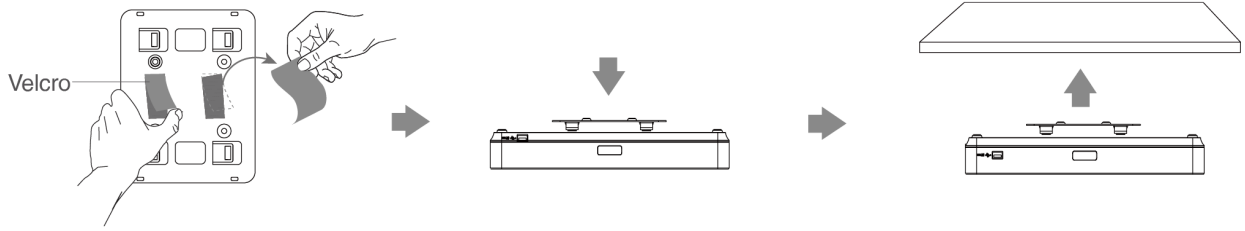

**Put on the Desk**

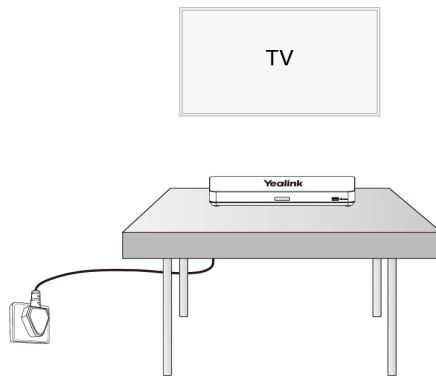

**Mount on the Rack**

1. Install the mounting ears on both sides of the AVHub.

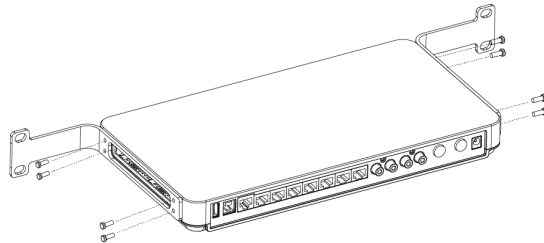

2. Push the AVHub into the rack, and then fix it to the rack with screws.

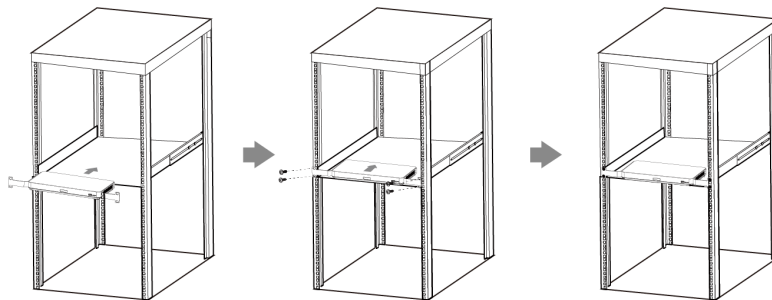

**NOTE**

- The rack in which the AVHub will be placed must be a 19-inch Rack compliant with IEC 60297.
- The Package Contents do not include screws.

**Connection**

When you connect the UVC84/UVC86 directly to the AVHub, the total number of connections must be no more than 4 devices. If the total number of connections exceeds 4 devices, you need to connect a PoE switch (the PoE switch must meet the 802.3 AT (PoE+) standard).

**VCS Deployment Solution**

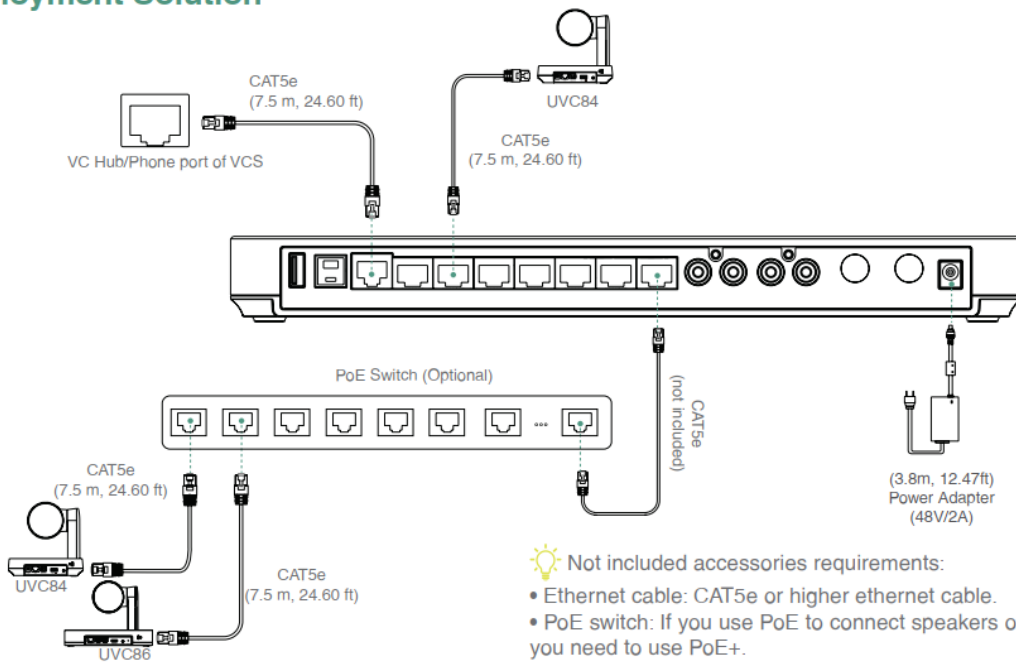

⚡ The VCS deployment solution supports only Camera devices in the current version.

**NOTE**

Not included accessories requirements:

- Ethernet cable: CAT5e or higher ethernet cable.
- PoE switch: If you use PoE to connect speakers or cameras, you need to use PoE+.